

Occhio

owner's manual

your
luminaire

Taglio tavolo fix

Thank
you

Vielen Dank, dass Sie sich für eine Leuchte von Occhio entschieden haben. Wir wünschen Ihnen viel Freude damit. Genießen Sie die neue Kultur des Lichts von Occhio!

Thank you for choosing a luminaire from Occhio. We hope it brings you plenty of joy. Enjoy the new culture of light from Occhio!

Nous vous remercions d'avoir choisi un luminaire Occhio et espérons que vous apprécierez votre produit. Profitez de la nouvelle culture de la lumière d'Occhio !

Gracias por elegir una lámpara de Occhio. Esperamos que disfrutes de ella. ¡Vive la cultura de la luz de Occhio!

Grazie per aver scelto una lampada Occhio e ci auguriamo che tu sia soddisfatto. Goditi la nuova cultura della luce di Occhio!

To those who strive for
new horizons.



Taglio tavolo fix

Markant, geradlinig und beweglich: Taglio vereint klare Formensprache mit höchstem Bedienkomfort – und öffnet mit Form und Funktion ein neues Kapitel für Design und Anwendung von Tischleuchten.

Striking, linear and flexible: Taglio combines clear design language with maximum ease of operation – and uses form and function to open a new chapter in the design and use of table luminaires.

Une esthétique saisissante, des lignes droites et épurées, une bonne mobilité : parfait mélange de fonction et d'esthétique, Taglio redéfinit la catégorie des lampes de table en matière de design et d'expérience utilisateur.

Llamativa, lineal y flexible: Taglio combina un lenguaje de diseño claro con la máxima facilidad de uso, y con su forma función abre un nuevo capítulo en el diseño y uso de lámparas de mesa.

Sorprendente, lineare e flessibile: Taglio coniuga un linguaggio chiaro e formale con la massima semplicità d'uso. E con la sua forma e le sue funzioni apre un nuovo capitolo nella storia del design e dell'impiego delle lampade da tavolo.

Taglio tavolo fix

Steuerung/Control/Contrôle/Controlar/Controllo	9
Occhio air	15
Montage/Mounting/Assemblée/Montaje/Assemblaggio	33



Taglio tavolo fix

Steuerung / Control / Contrôle / Controlar / Controllo

touchless control

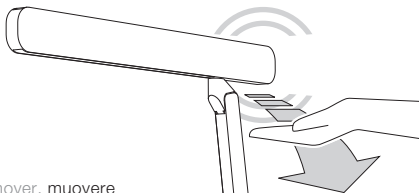
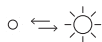

on / off

bewegen, move, déplacer, mover, muovere

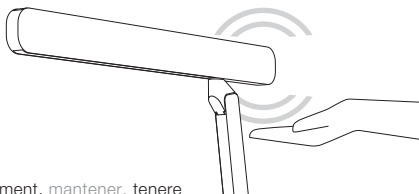
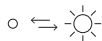

dim

halten, hold, appuyer longuement, maintenir, tenere

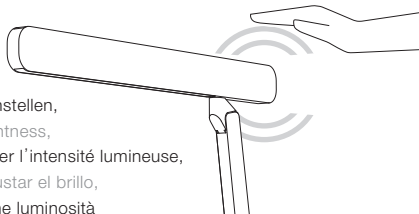

up / down fading

lange halten → Helligkeit einstellen,

keep holding → Adjust brightness,

appuyer longuement → régler l'intensité lumineuse,

mantener más tiempo → ajustar el brillo,

tenere a lungo → regolazione luminosità

2700 K

4000 K

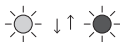

color tune

halten → Farbtemperatur einstellen,

last long → adjust the color temperature,

tenir → ajuster la température de la couleur,

mantener → ajustar la temperatura de color,

tenere → regolazione della temperatura di colore

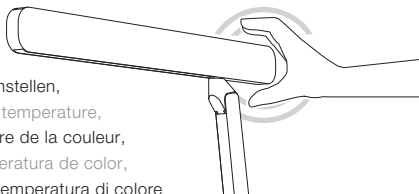

infinite move

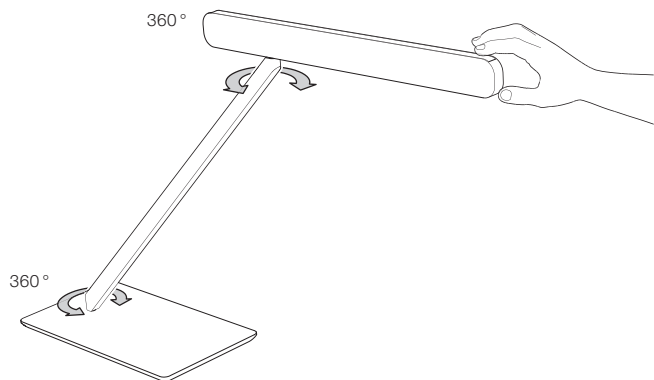

Occhio air



App installieren und öffnen.

Install and open the app.

Installer et ouvrir l'application.

Instala y abre la aplicación.

Installare e aprire l'applicazione.

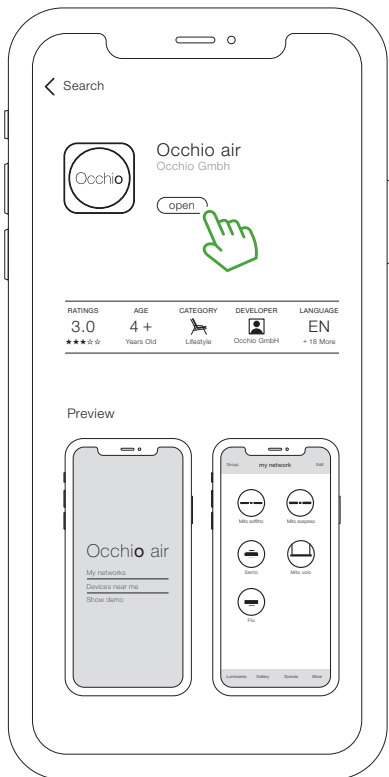

Angeschlossene Leuchten einrichten und Netzwerk erstellen.

Set up connected luminaires and create network.

Configurer les luminaires connectés et créer un réseau.

Configurar las luminarias conectadas y crear una red.

Impostare gli apparecchi collegati e creare una rete.

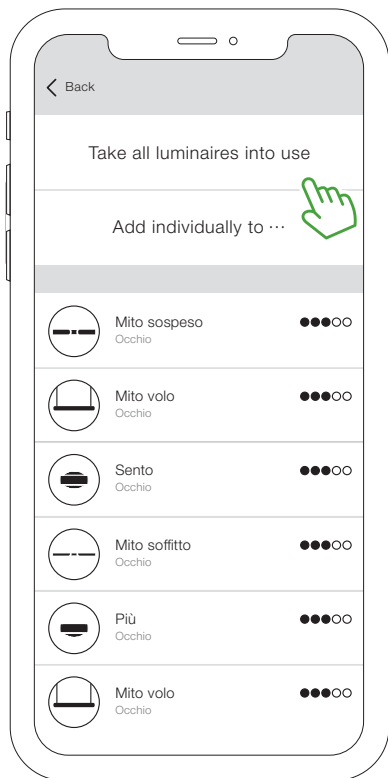

Leuchten steuern.

Control luminaires.

Apparecchi di controllo.

Luminarias de control.

Apparecchi di controllo.

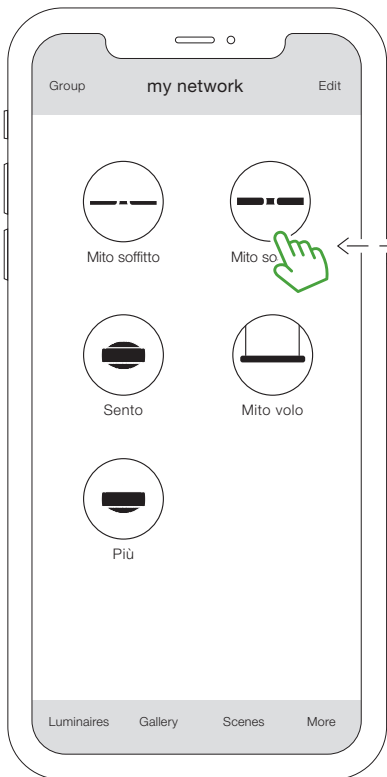

Steuerungsgesten.
 Control gestures.
 Gestes de contrôle.
 Gestes de contrôle.
 Gesti di controllo.

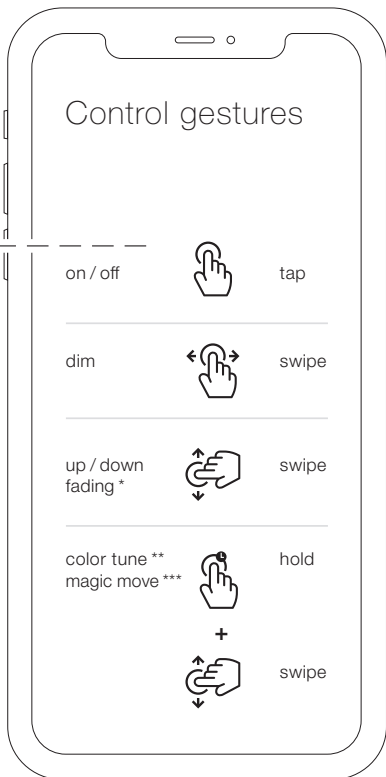

Nur bei Leuchten mit beidseitigem
 Lichtaustritt*, color tune**
 oder magic move***

Only for luminaires with double-
 sided light output*, color tune**
 or magic move***

Uniquement pour les luminaires avec
 rendement lumineux double face*,
 color tune** ou magic move***.

Sólo para luminarias con salida
 de luz de doble cara*, color tune**
 o magic move***

Solo per apparecchi con emissione
 luminosa su entrambi i lati*,
 color tune** o magic move***

Netzwerk teilen: Optional kann nun das erstellte Netzwerk (my network) mit anderen geteilt werden.

share network: Optionally, the created network (my network) can now be shared with others.

partager le réseau : En option, le réseau créé (mon réseau) peut maintenant être partagé avec d'autres personnes.

compartir red: Opcionalmente, la red creada (mi red) puede ahora ser compartida con otros.

condividi rete: Opzionalmente, la rete creata (la mia rete) può ora essere condivisa con altri.

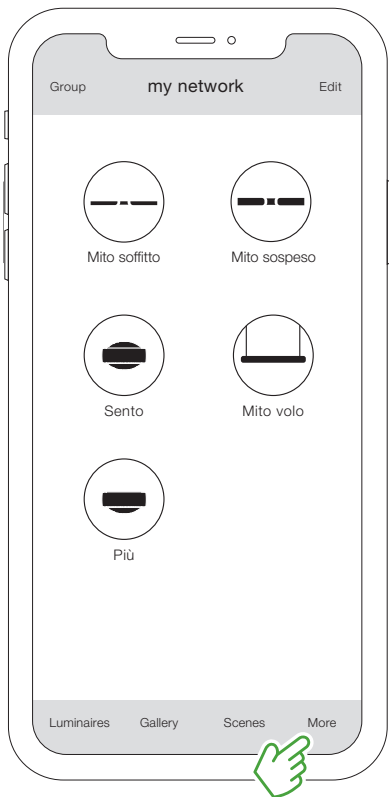

Netzwerknamen vergeben.

Assign network name.

Attribuer un nom de réseau.

Asigna el nombre de la red.

Assegnare il nome della rete.

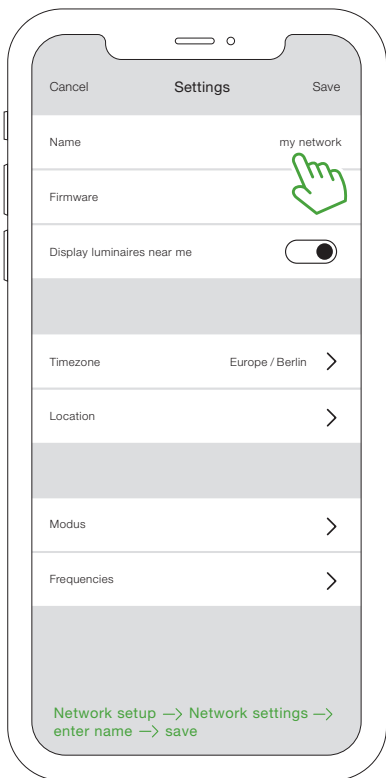

Netzwerk freigeben.
Share network.
Partager le réseau.
Comparte la red.
Condividere la rete.

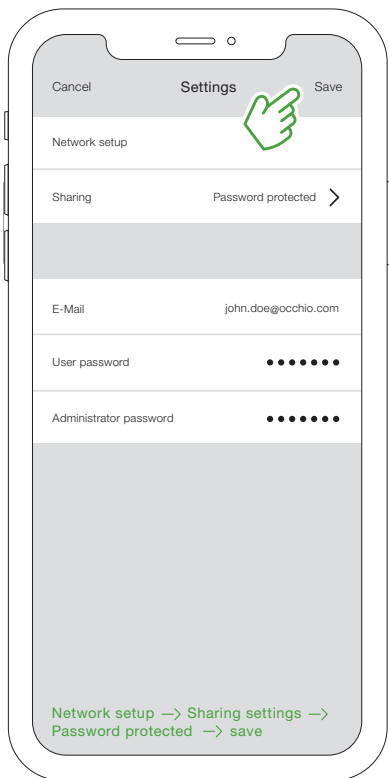

Occhio air sync

Leuchten im Netzwerk gruppieren und features mittels touchless control gemeinsam steuern.

Group luminaires in a network and control features with touchless control together.

Regroupez les luminaires dans un réseau et contrôlez ensemble les fonctions avec la touchless control.

Agrupe las luminarias en una red y controle las funciones con touchless control de forma conjunta.

Raggruppate gli apparecchi in una rete e controllate insieme le funzioni con il touchless control.

*Funktionen abhängig vom Leuchtenmodell.

*Fonctions depending on luminaire model.

*Fonctions dépendant du modèle de luminaire.

*Las funciones dependen del modelo de luminaria.

*Le funzioni dipendono dal modello di apparecchio.

Einstellungen der Leuchte öffnen.

Open settings of the luminaire.

Ouvrir les réglages du luminaire.

Abrir los ajustes de la luminaria.

Aprire le impostazioni dell'apparecchio.

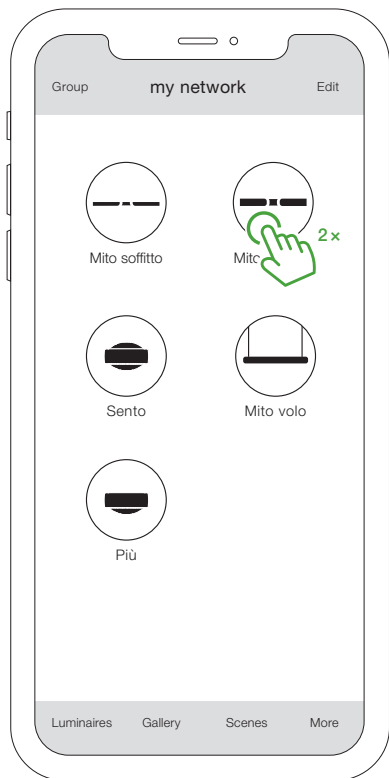

Parameter: Zusatzoptionen der Leuchte aktivieren oder Einstellungen vornehmen (air sync, air sync height, presence sensor, ambient light control)*

Parameter: Activate additional options of the luminaire or make settings (air sync, air sync height, presence sensor, ambient light control)*

Paramètre : Activez des options supplémentaires du luminaire ou effectuez des réglages (air sync, air sync height, presence sensor, ambient light control)*.

Parámetros: Activar opciones adicionales de la luminaria o realizar ajustes (air sync, air sync height, presence sensor, ambient light control)*.

Parametri: Attivare opzioni aggiuntive dell'apparecchio o effettuare impostazioni (air sync, air sync height, presence sensor, ambient light control)*.

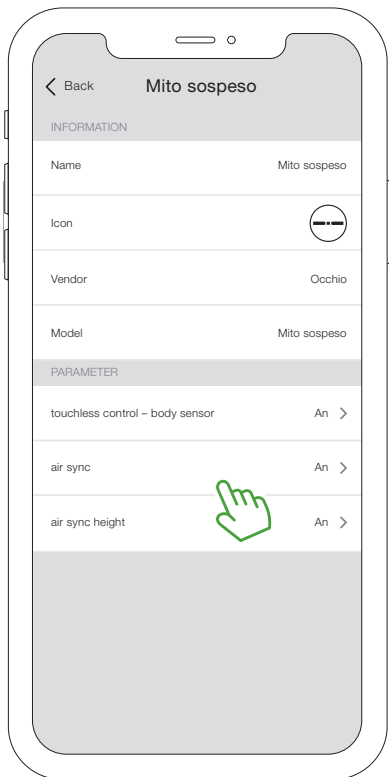

Gruppe erstellen.
Create a group.
Créez un groupe.
Crea un grupo.
Creare un gruppo.

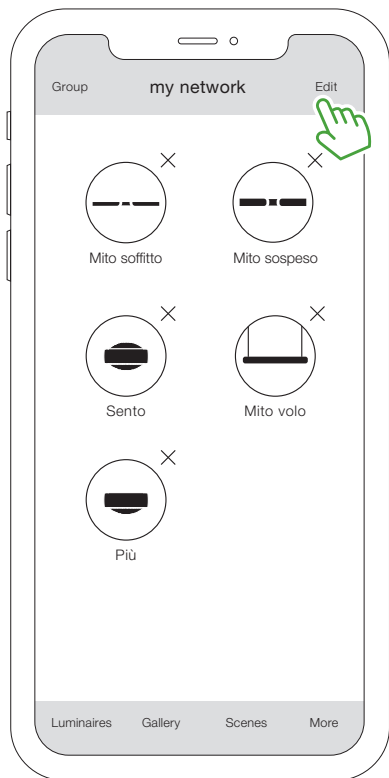

Leuchtsymbole übereinanderlegen.

Superimpose luminaire icons.

Superposer les icônes des luminaires.

Superponer iconos de luminarias.

Superponer iconos de luminarias.

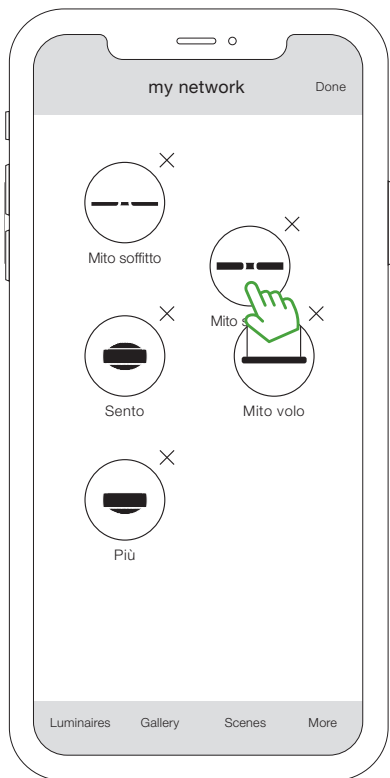

Bearbeiten beenden.

Exit edit.

Montage de sortie.

Edición de salida.

Modifica dell'uscita.

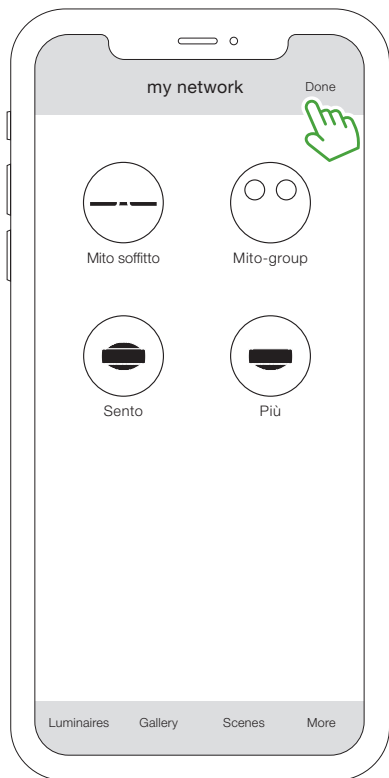

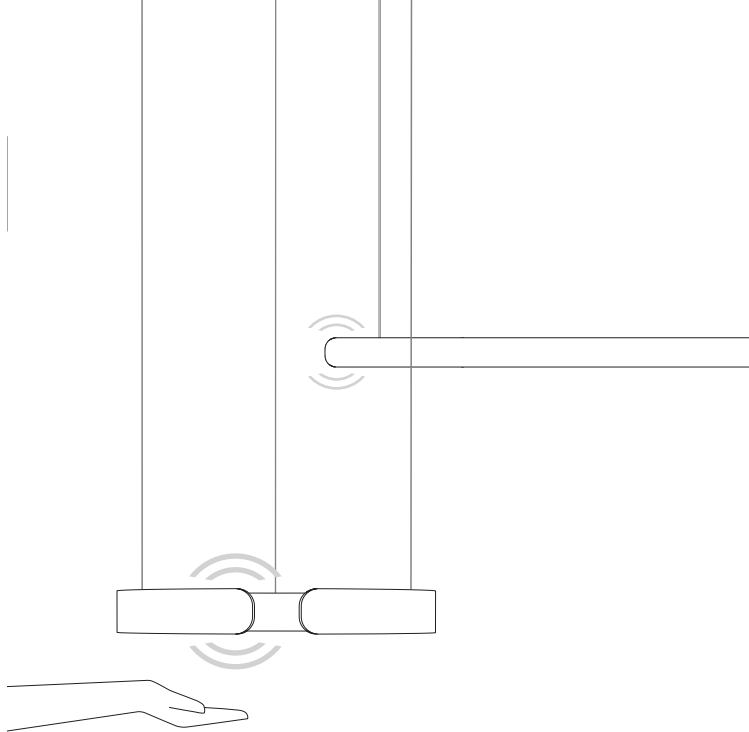



Die synchronisierten Leuchten, innerhalb einer Gruppe, können nun gemeinsam mittels touchless control gesteuert werden.

Weitere Infos unter: www.occhio.com/faq

The synchronized luminaires within a group can now be controlled together with touchless control.

Further info at: www.occhio.com/faq

Les luminaires synchronisés au sein d'un groupe peuvent désormais être contrôlés ensemble grâce à la touchless control.

Plus d'informations : www.occhio.com/faq

Las luminarias sincronizadas dentro de un grupo pueden ahora controlarse conjuntamente con el touchless control.

Más información en: www.occhio.com/faq

Gli apparecchi sincronizzati all'interno di un gruppo possono ora essere controllati insieme con il touchless control.

Ulteriori informazioni su: www.occhio.com/faq

Taglio tavolo fix

Montage / Mounting / Assemblée / Montaje / Assemblaggio

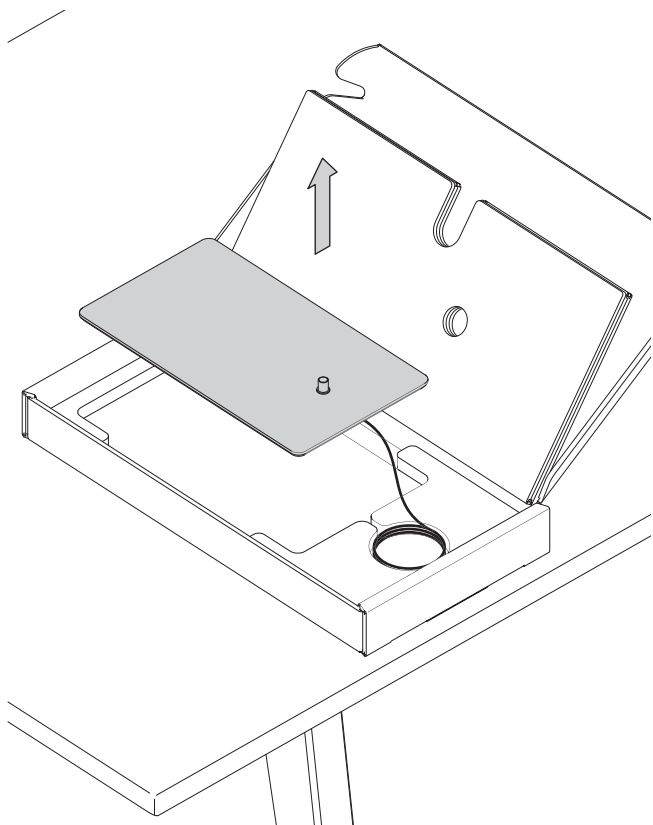

Füße wie abgebildet montieren.

Assemble the feet as shown.

Monter les pieds conformément au schéma.

Monte el pie como se muestra.

Montare i piedini come illustrato.

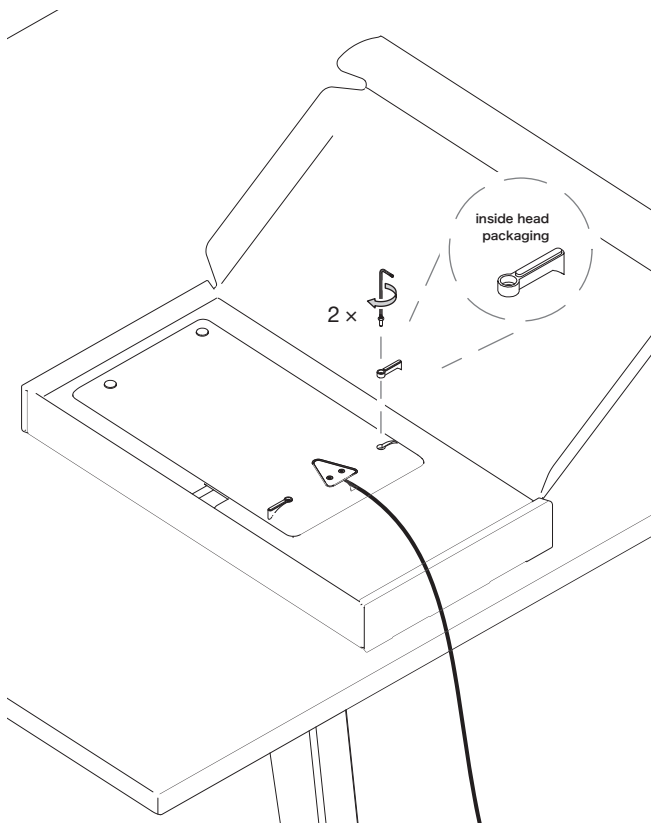

Den body aufstecken.

Attach the body.

Brancher le corps.

Inserte el cuerpo.

Inserire il corpo.

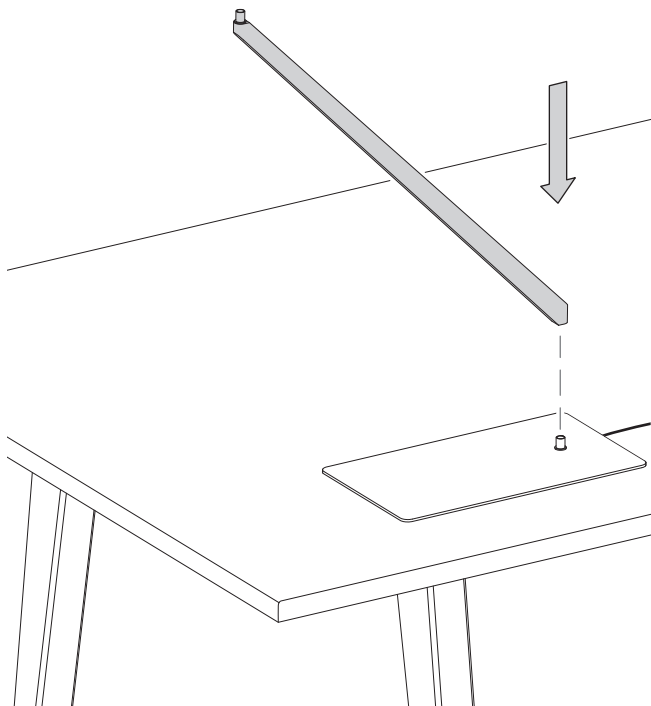

Den head aufstecken.

Attach the head.

Brancher la tête.

Inserte el cabezal.

Inserire la testa.

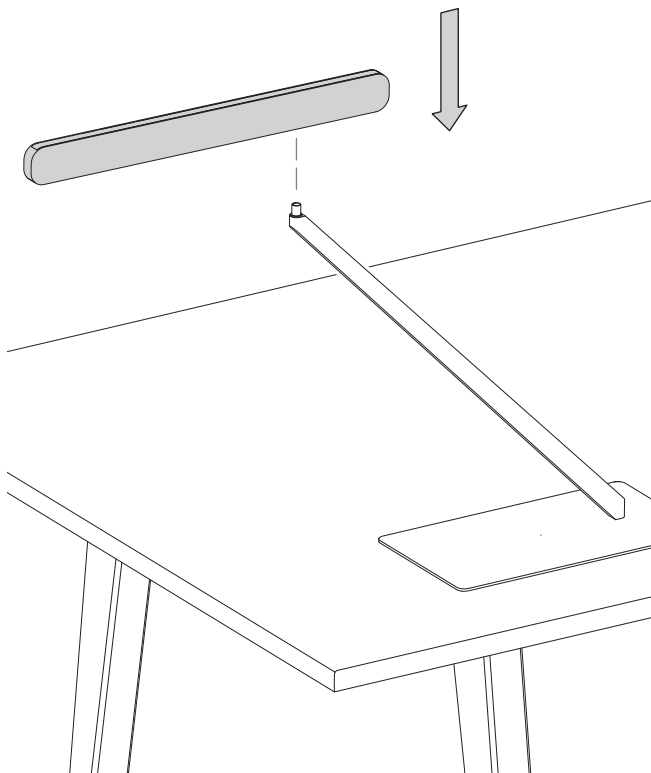

Buchse ausklappen und Kabel einstecken.

Open the socket and insert cable.

Déplier les connecteurs et insérer le câble.

Despliegue enchufe y enchufe el cable.

Aprire la presa e inserire il cavo.

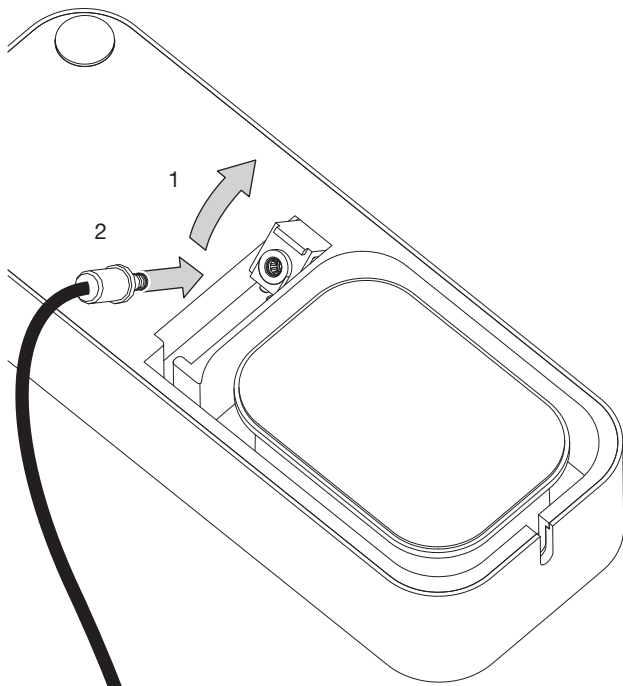

Buchse einklappen und Kabel, bis die gewünschte Länge erreicht ist, aufwickeln.

Close the socket and wrap the cable until it reaches the desired length.

Replier les connecteurs et embobiner le câble jusqu'à obtenir la longueur souhaitée.

Doble el enchufe y enrolla el cable hasta alcanzar la longitud deseada.

Richiudere la presa e avvolgere il cavo fino a raggiungere la lunghezza desiderata.

