

LEVANTE

design Marco Spatti

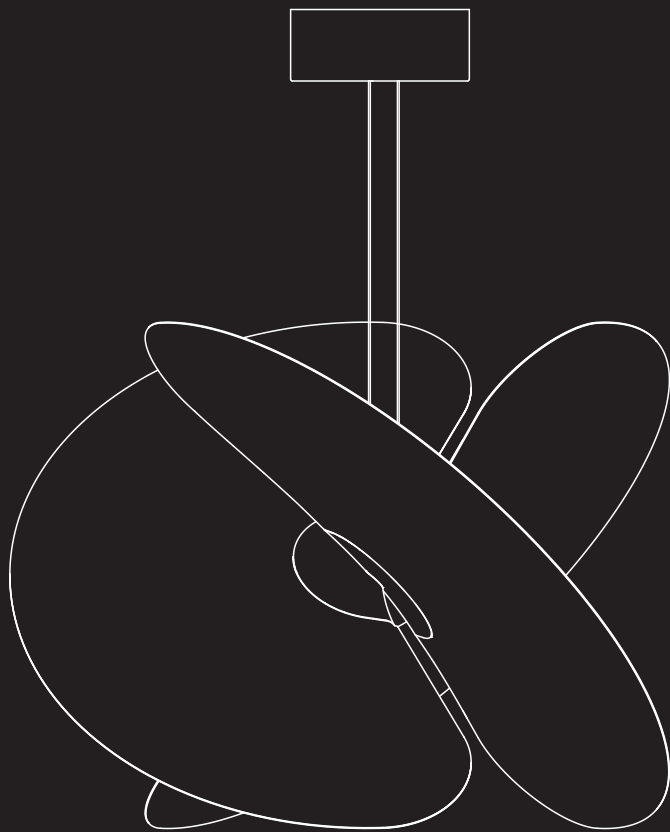

**LUCE
PLAN**

A06



A06/1T - A06/2T

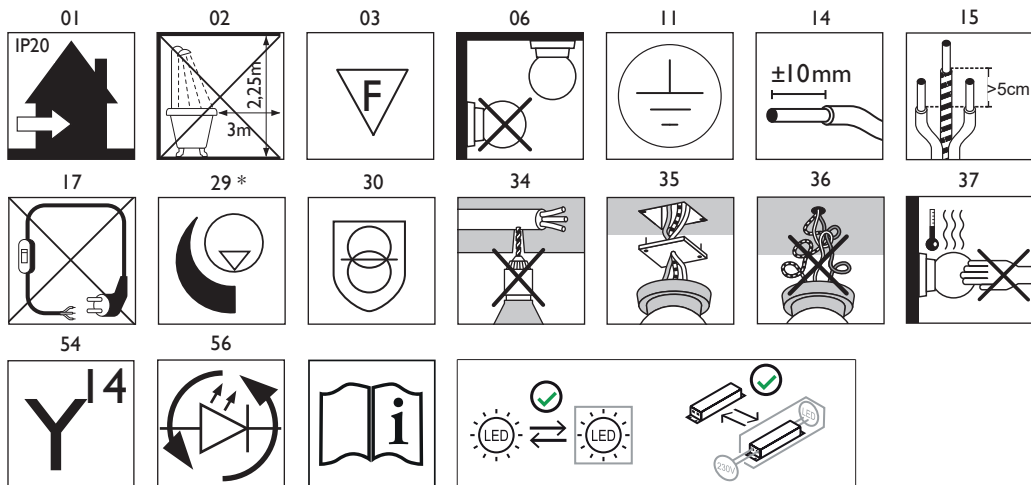

29* Levante drivers are suitable for use with Trailing edge dimm

A06/1D - A06/2D

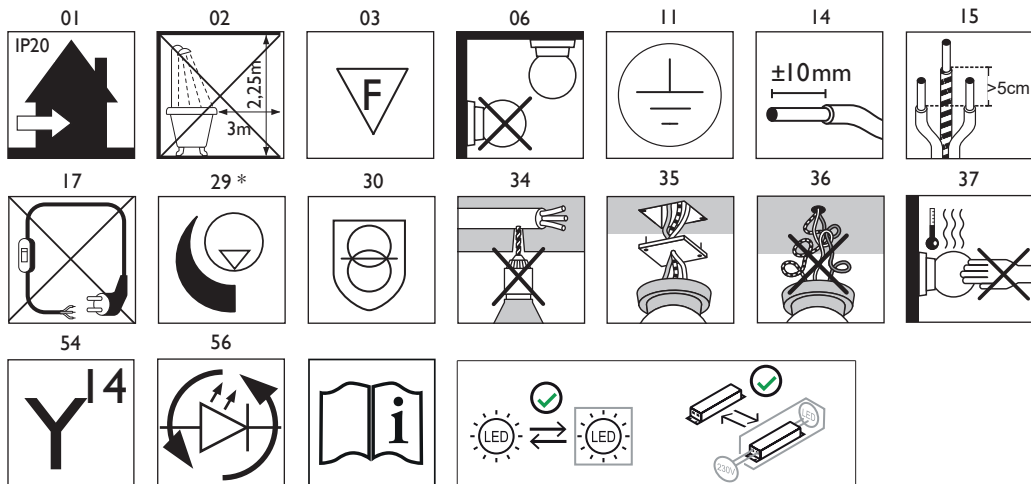

29* Levante drivers are suitable for use with DALI - Push dimm

A06/1D
 A06/1T
 +
 A06C1

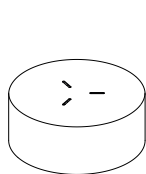
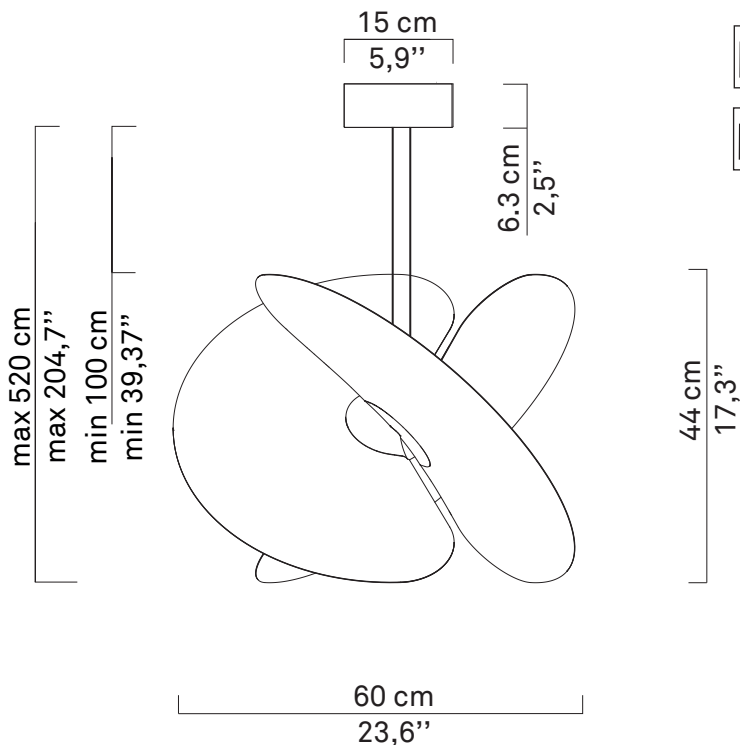

X1

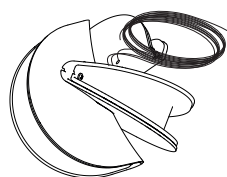

X1



X1

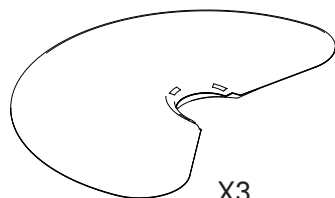

X3

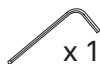

x 1

kg 2,5 kg

lb 5,51 lb

A06/2D
A06/2T
+
A06C2

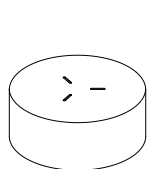
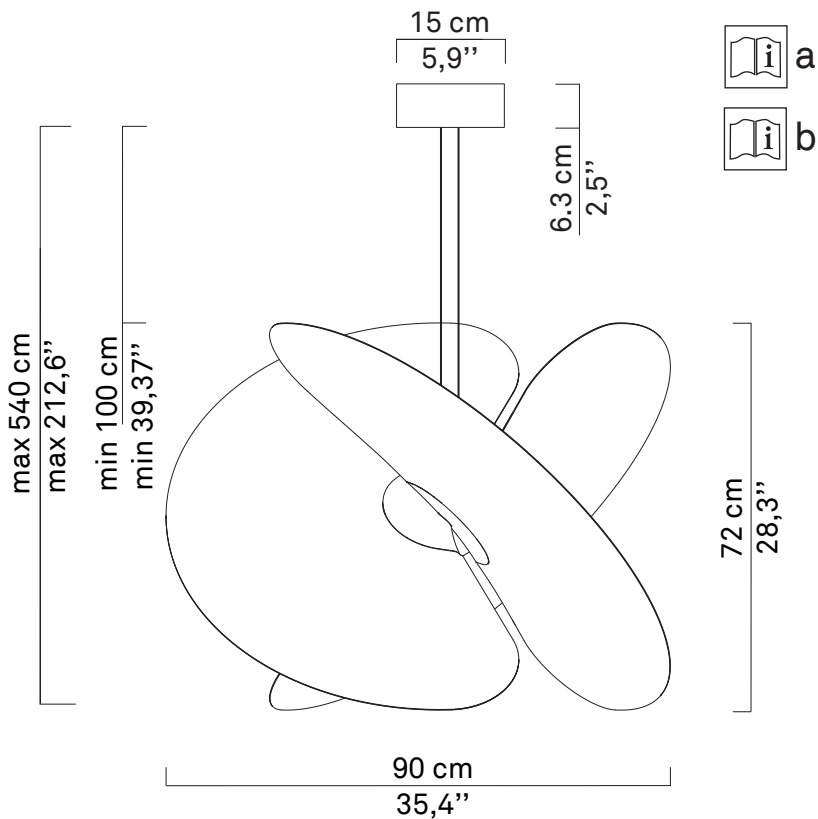

X1



X1

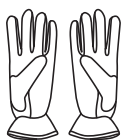

X1

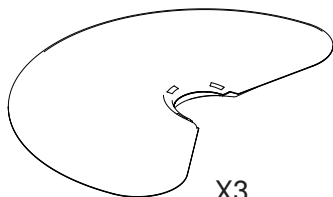

X3



x 1



x 6



x 1

kg 5,4 kg

lb 11,9 lb

1 | 1.1

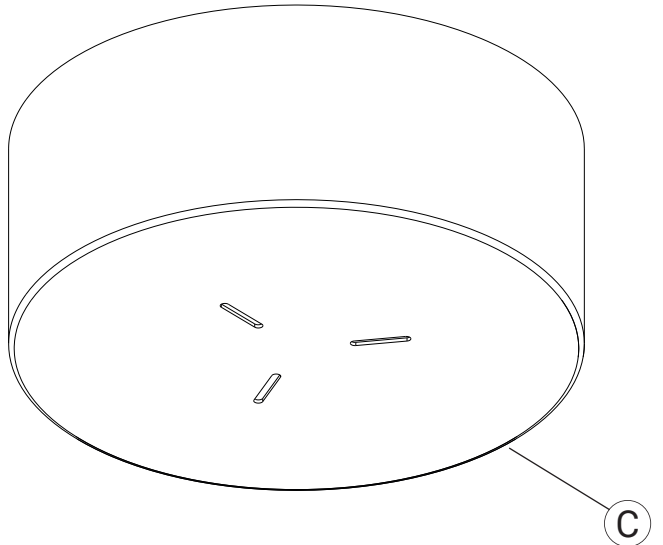
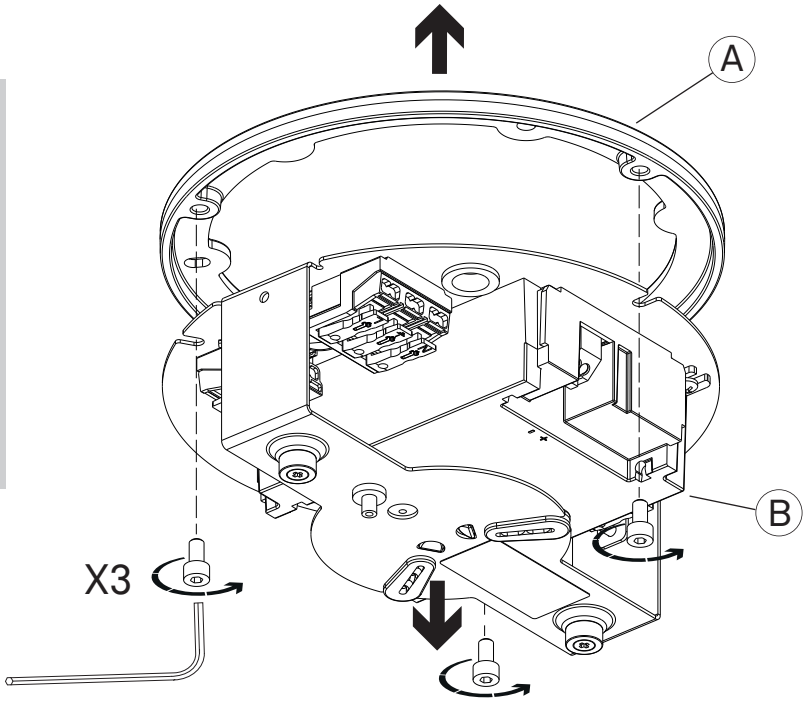
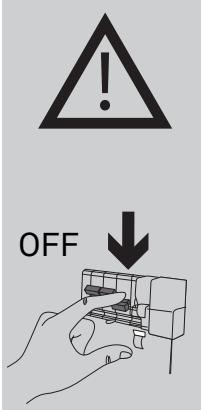

1.2

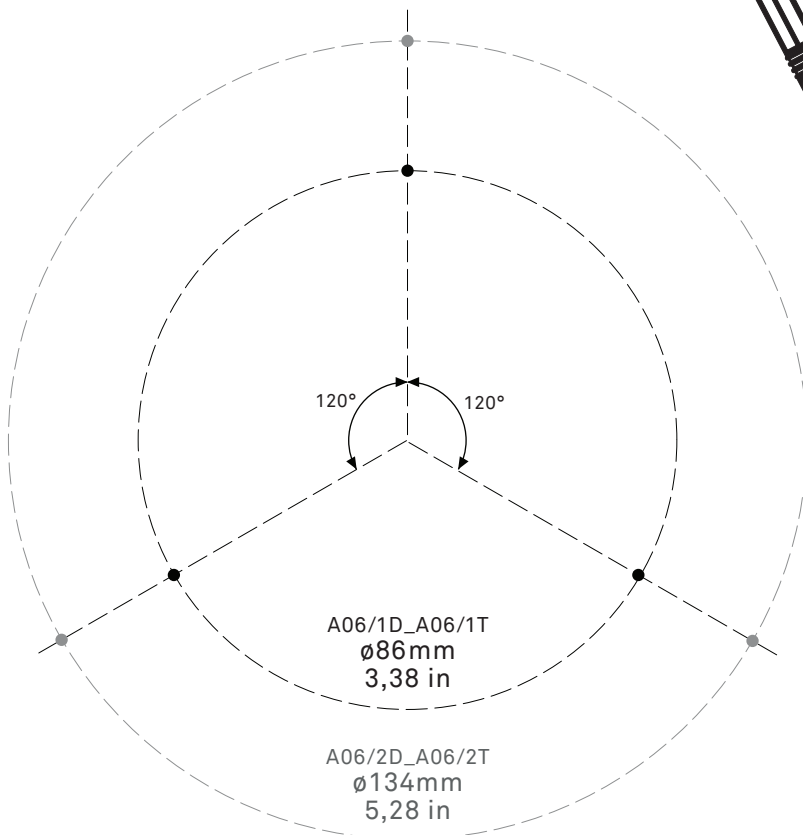
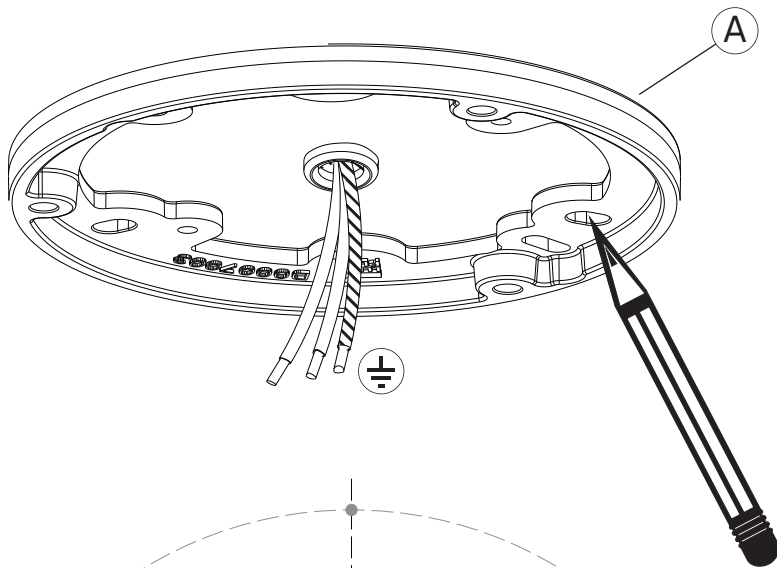

1.3

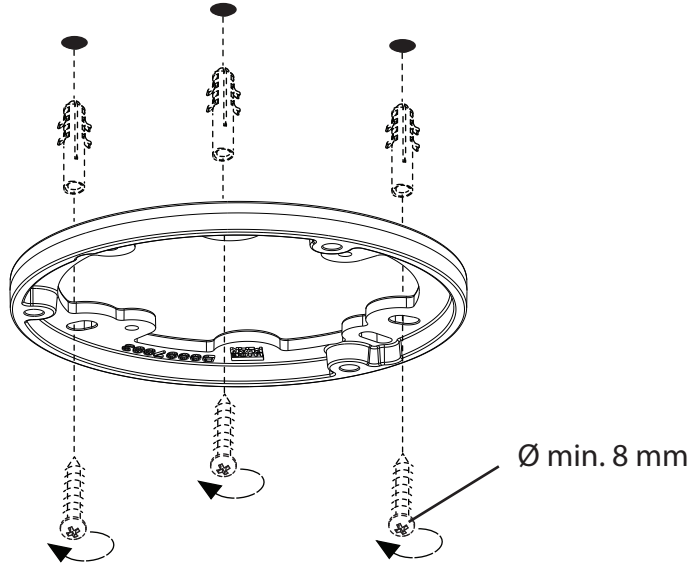

1.4

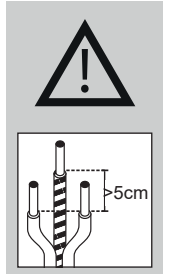
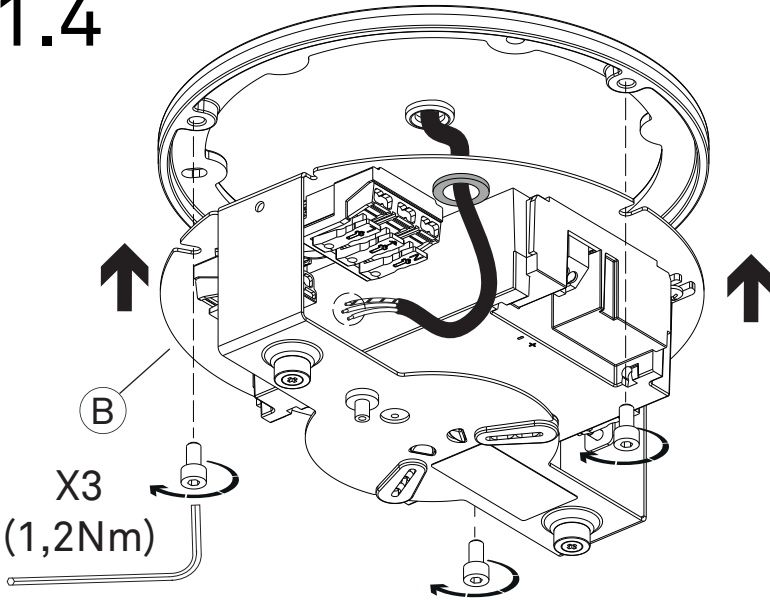

1.5

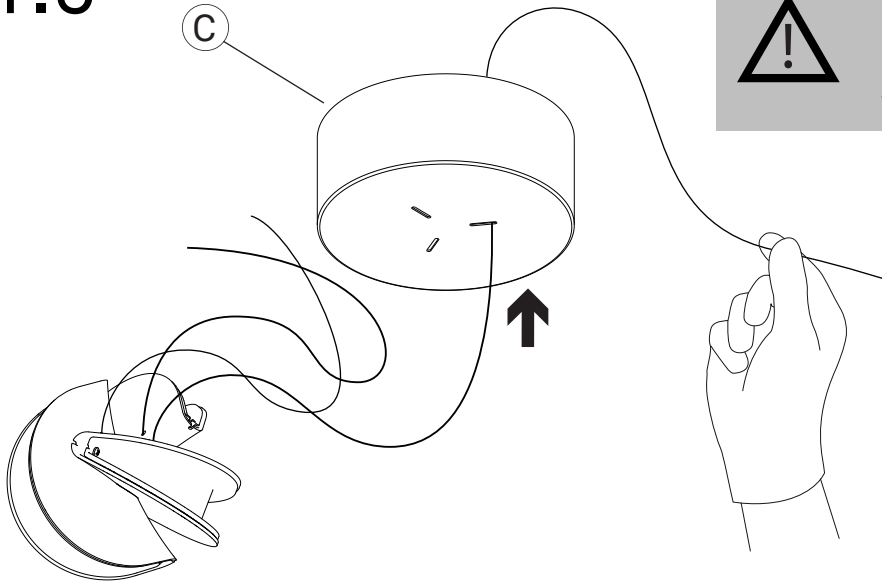

1.6

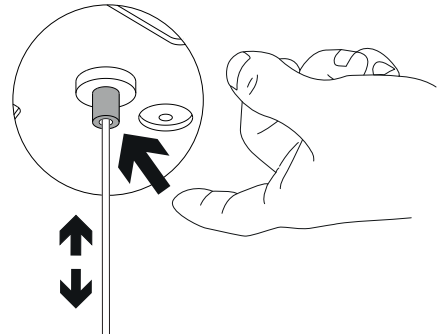
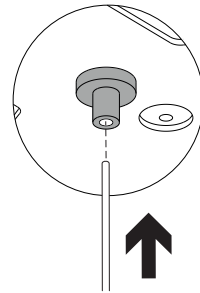
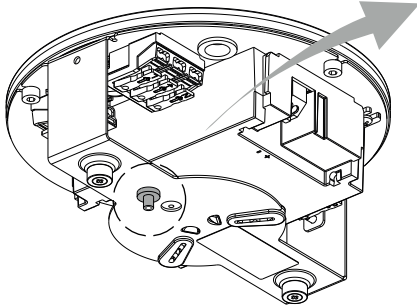

IT solo cavo in acciaio

EN steel wire only

DE nur stahlkabel

FR seulement câble en acier

ES cable de acero solamente



1.8

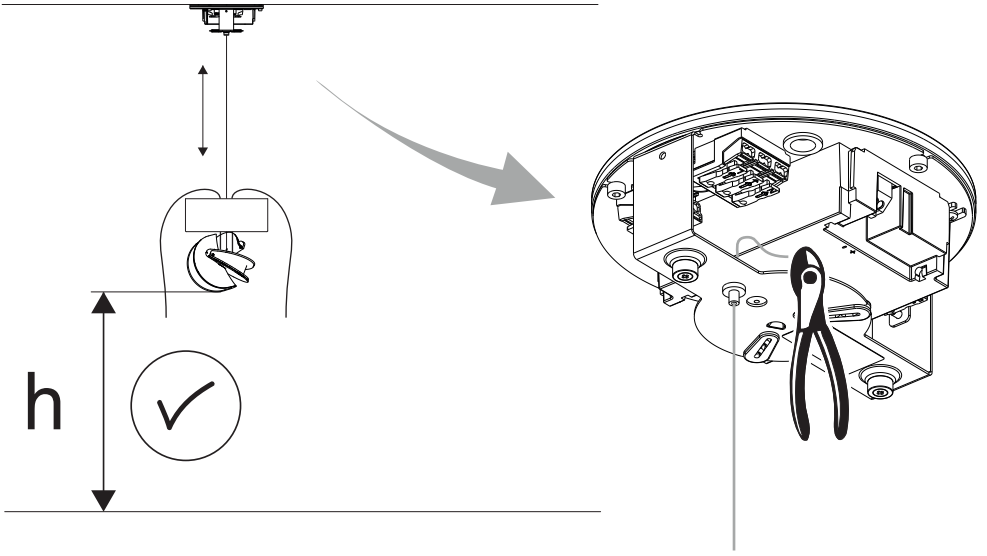

1.9

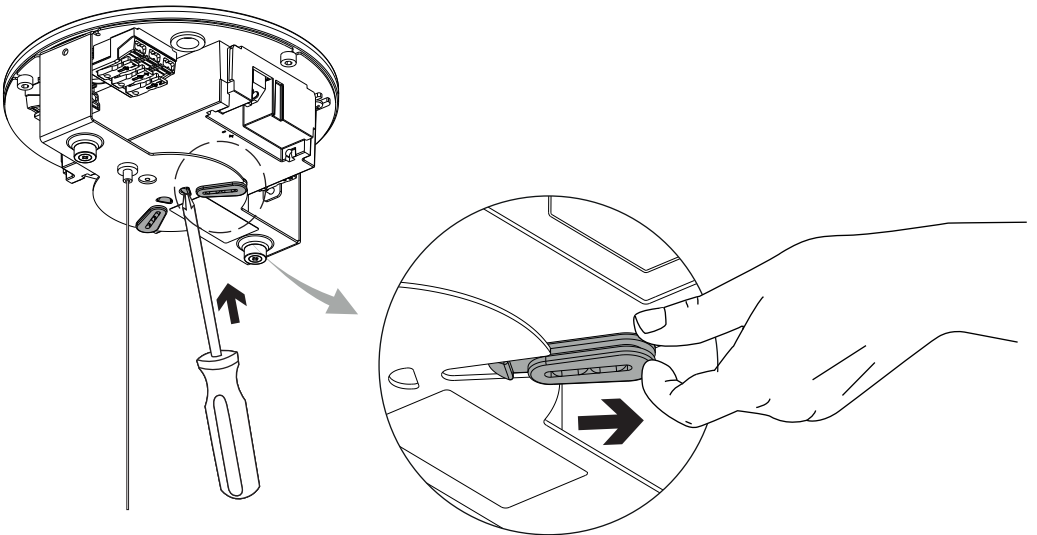

1.10

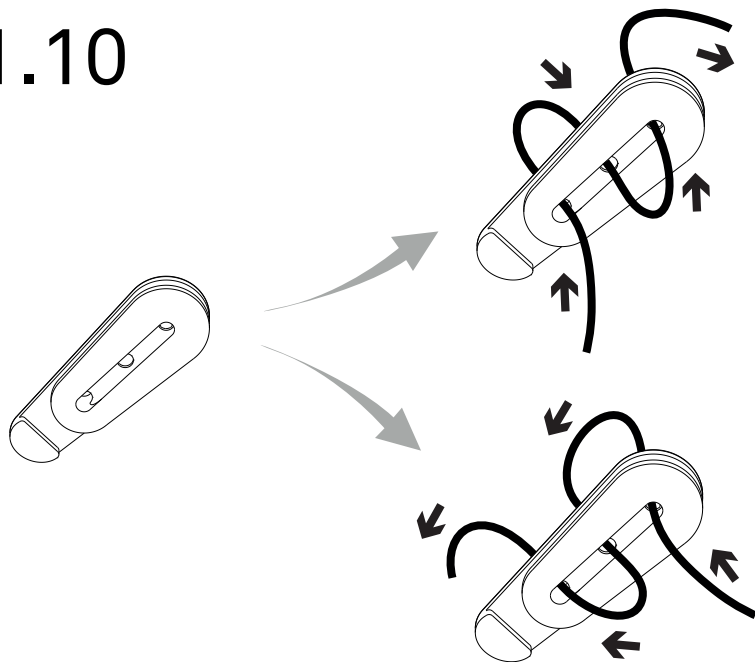

A06/1D
A06/1T

A06/2D
A06/2T

1.11

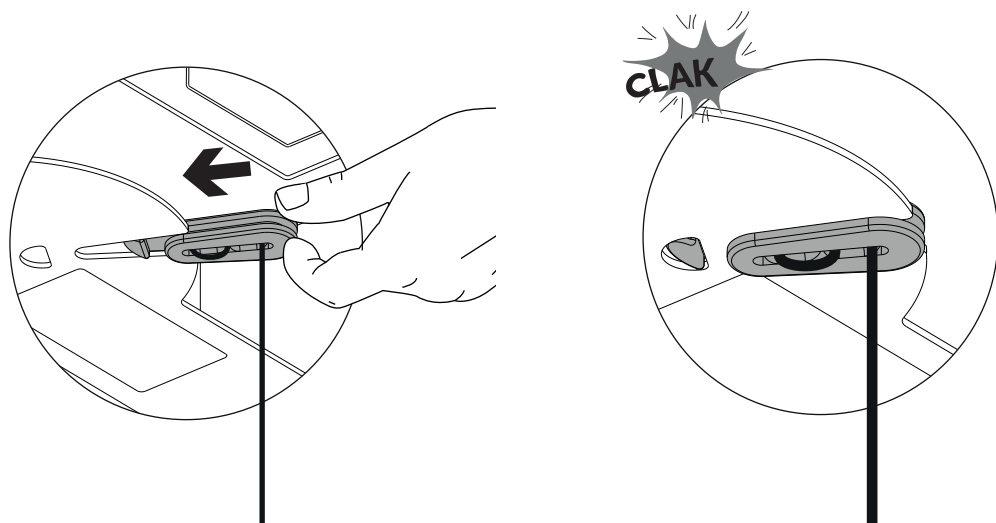

1.12

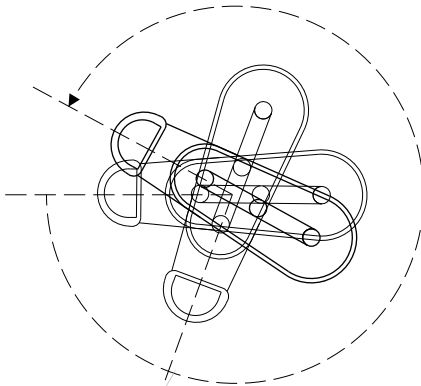
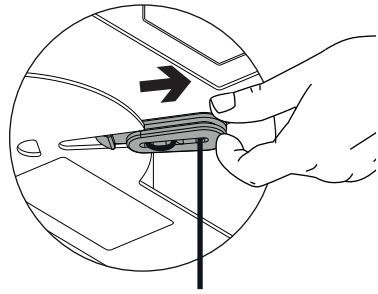
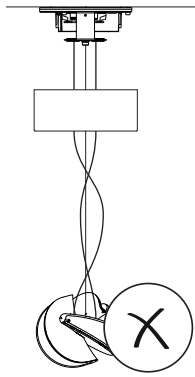

- IT** ruotare in senso orario o antiorario
- EN** rotate clockwise or counterclockwise
-  **DE** um im Uhrzeigersinn oder gegen den Uhrzeigersinn drehen
- FR** tourner dans le sens horaire ou antihoraire
- ES** gírelo en el sentido del reloj o contrarreloj

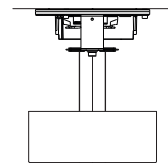
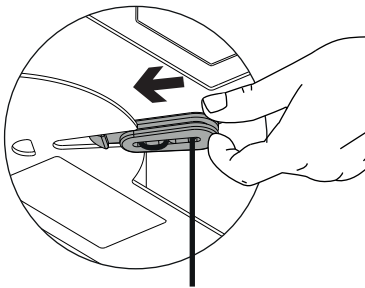

2 A06/1T _ A06/2T

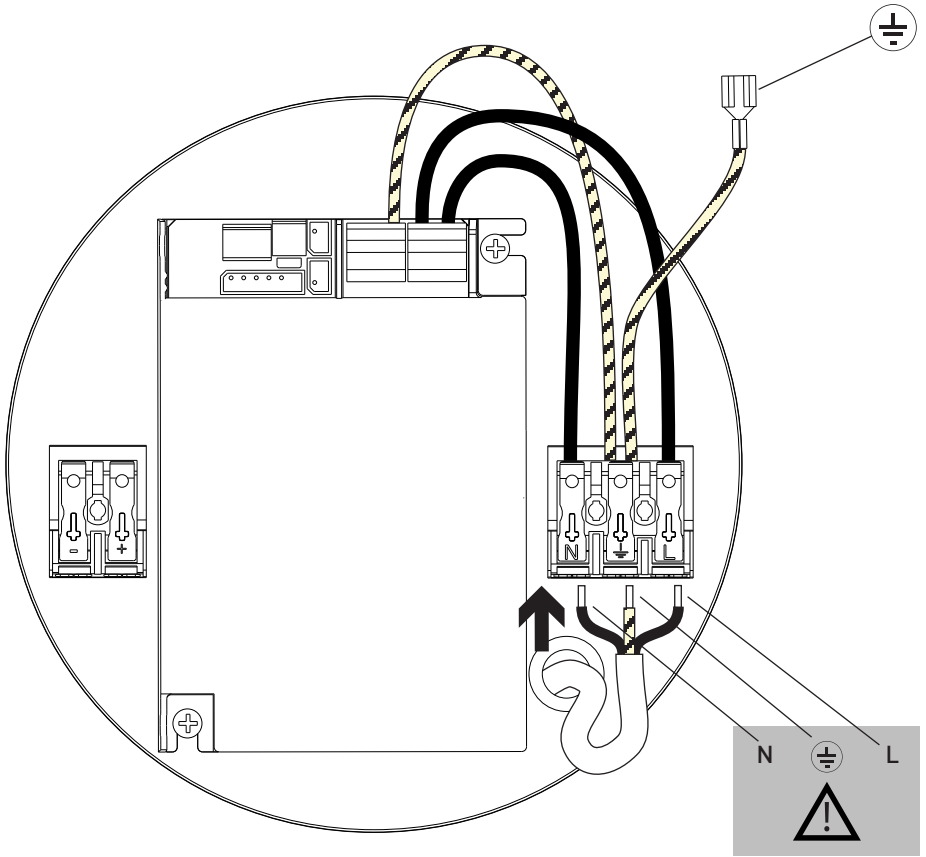

A06/1D _ A06/2D

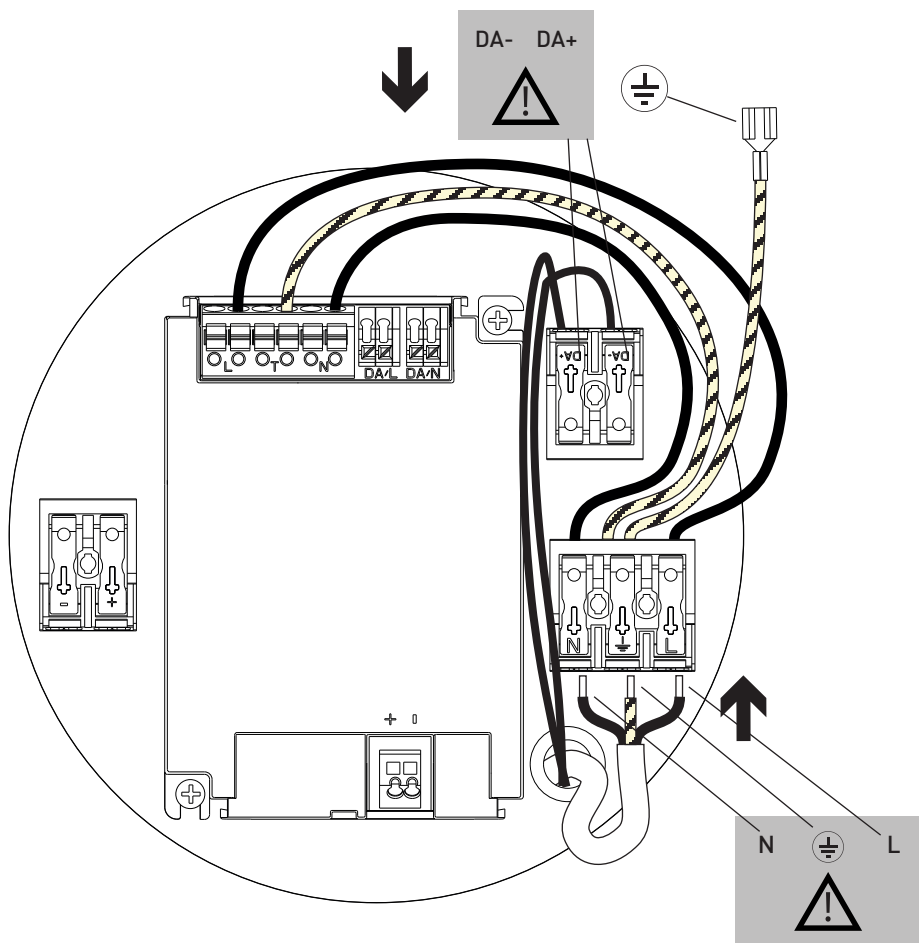

A06/1D _ A06/2D

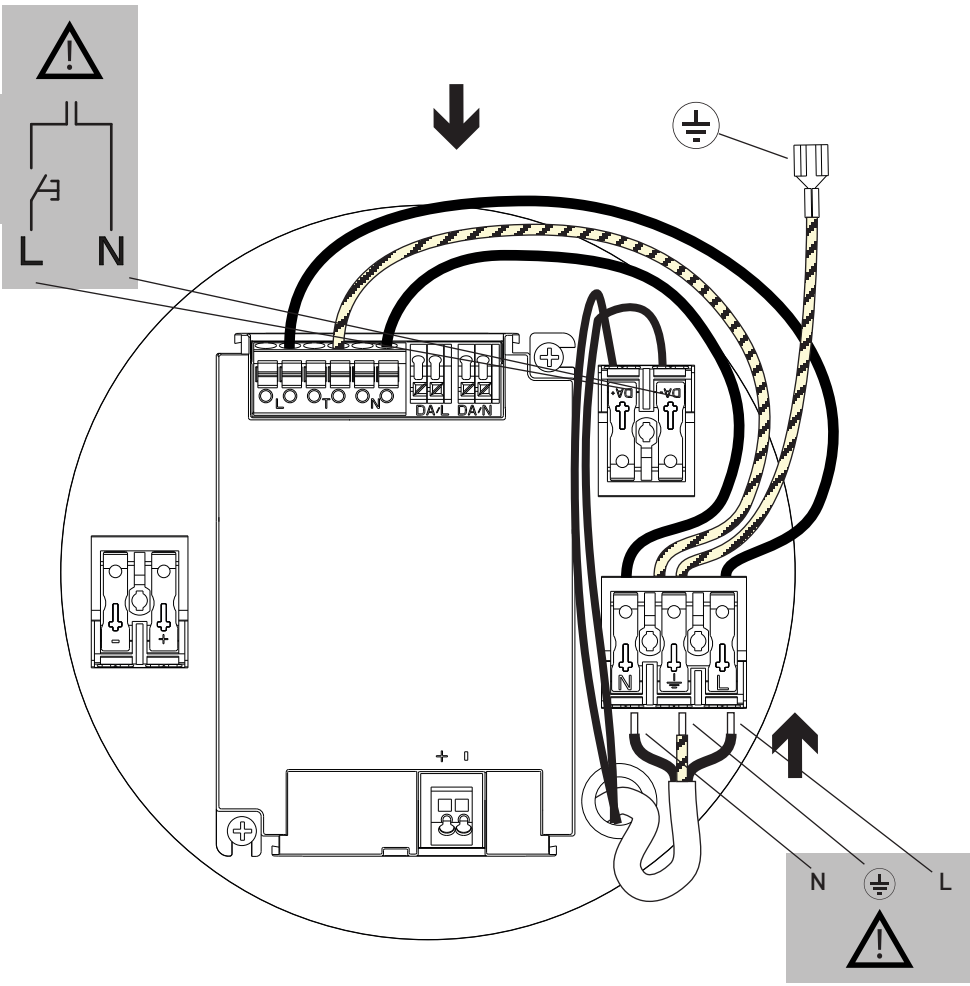
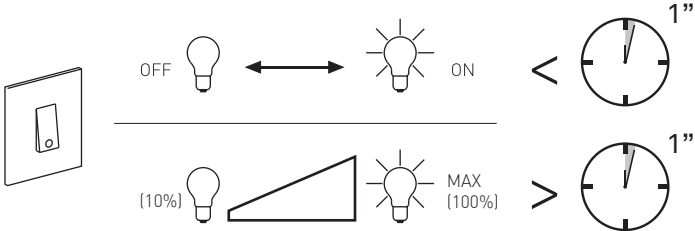

3 | 3.1

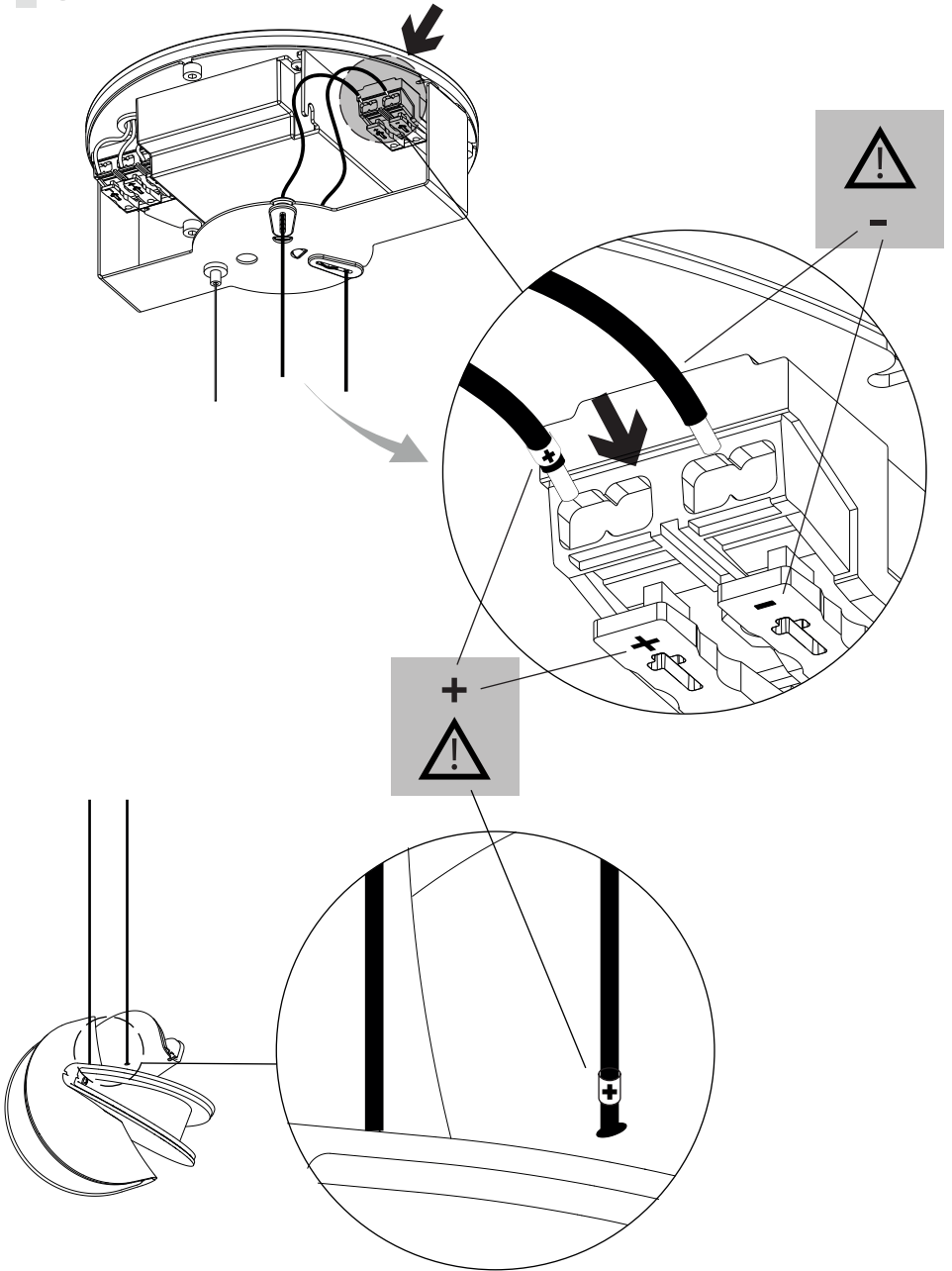

3.2

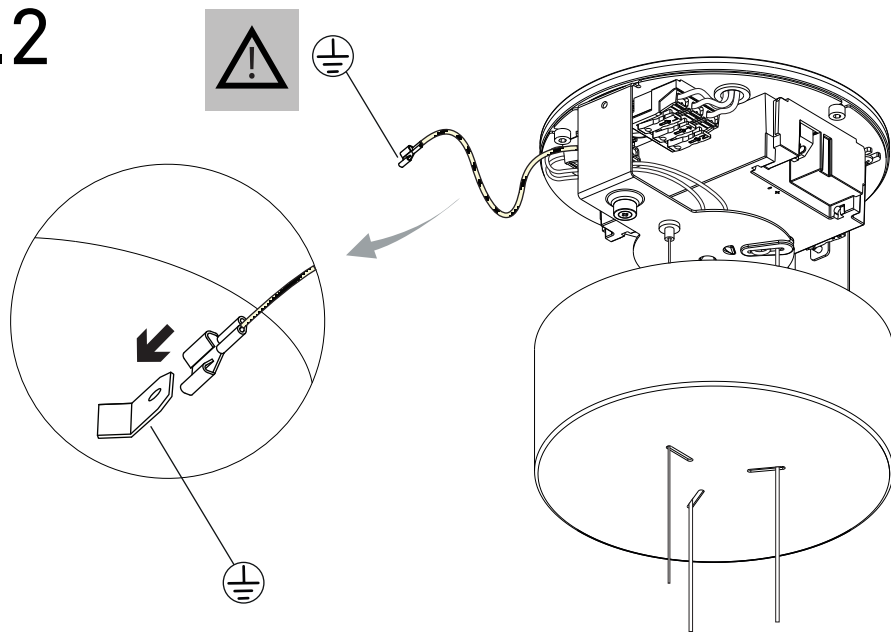

3.3

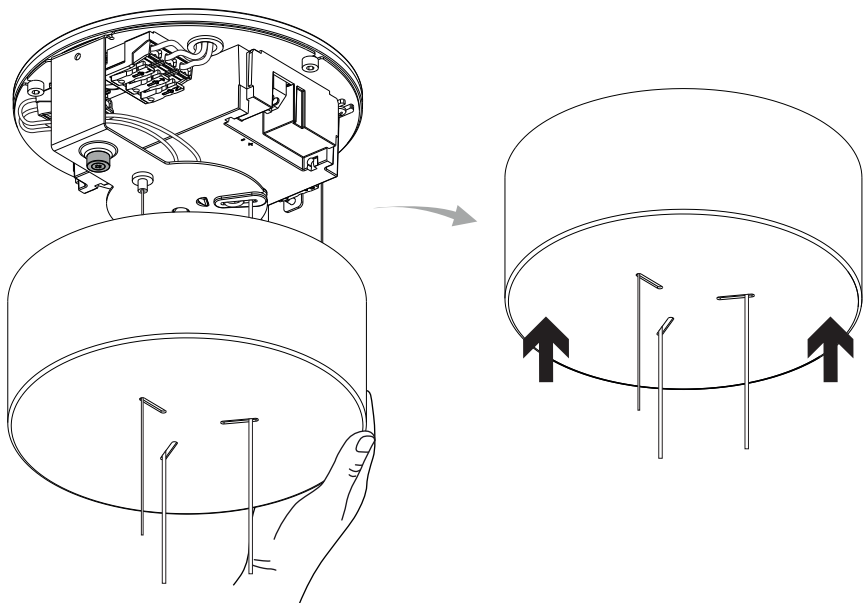

4

A06/1D-A06/1T+A06C1

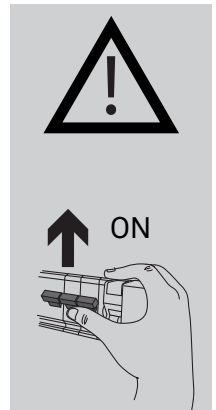
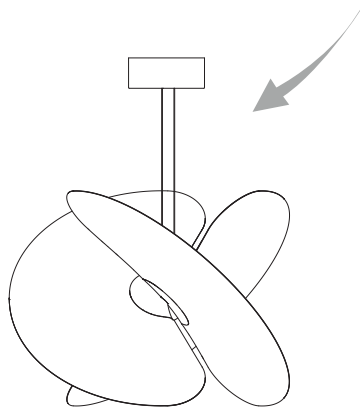
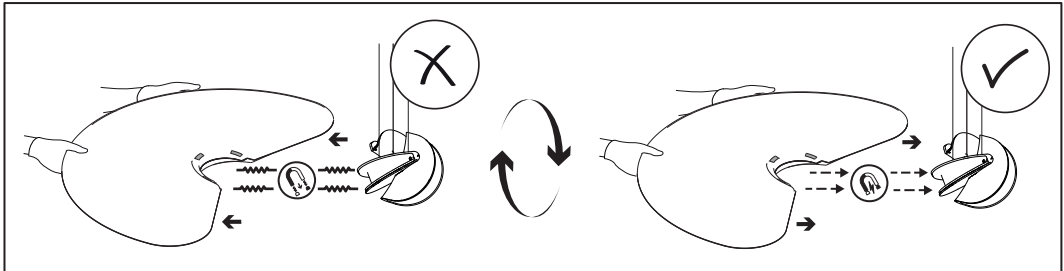
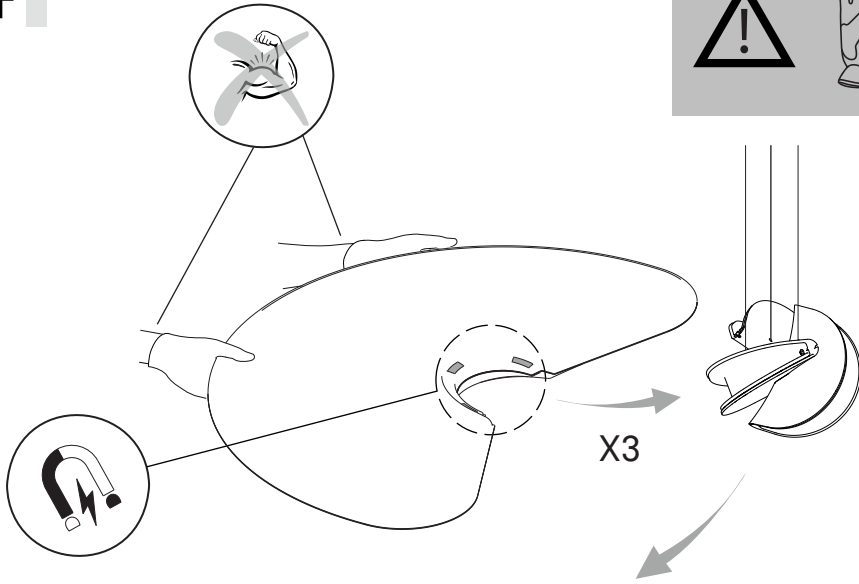

A06/2D-A06/2T+A06C2

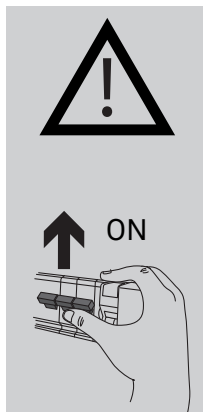
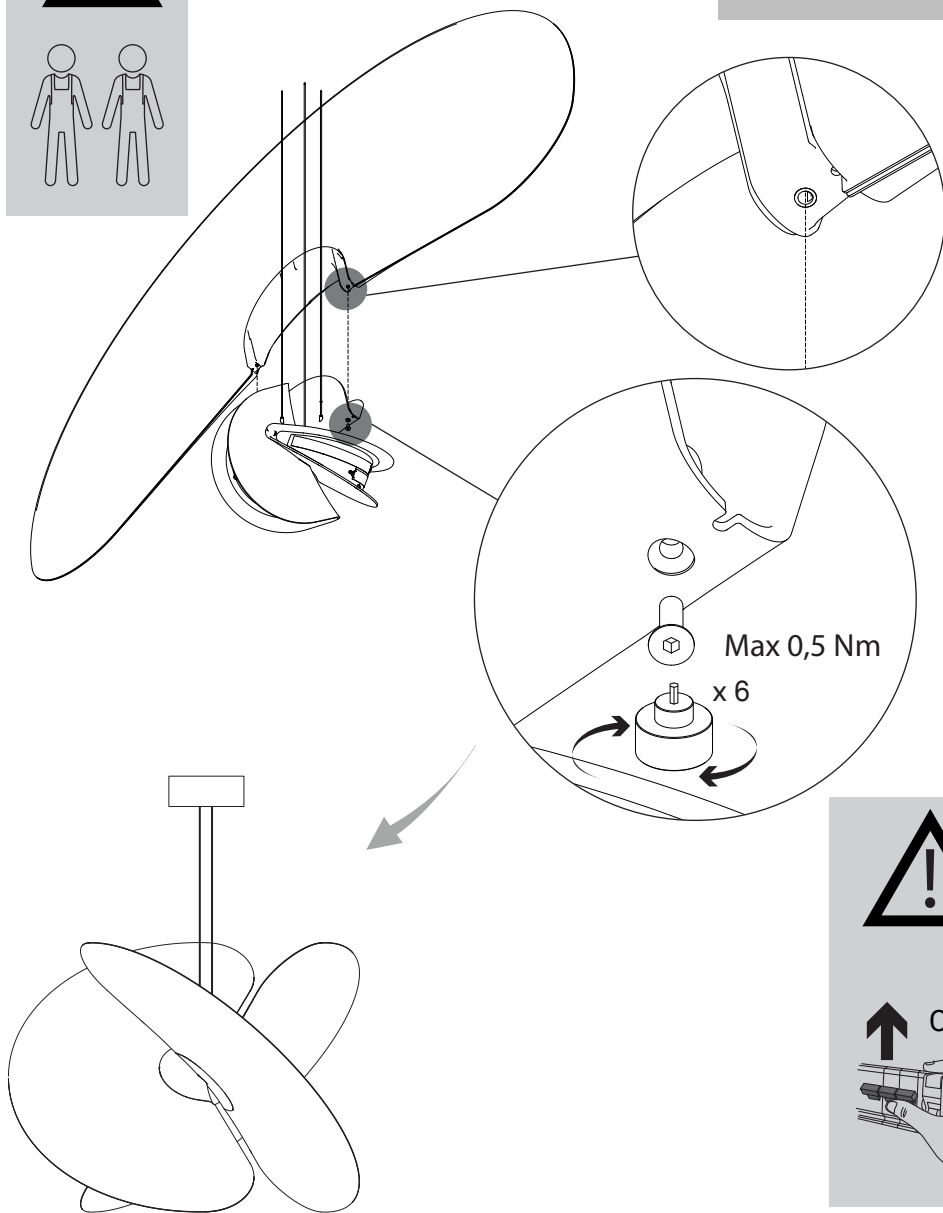
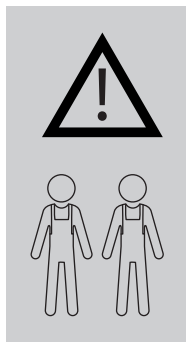

ECODESIGN

SYMBOL LEGEND

LEGENDA DEI SIMBOLI

ERLÄUTERUNG DER SYMBOLE

LEGENDE DES SYMBOLES

LEYENDA DE LOS SIMBOLOS



Replaceable light source by end-user
Fonte luminosa sostituibile dal cliente finale
Auswechselbare Lichtquelle durch den Endanwender
Source lumineuse remplaçable par l'utilisateur final
Fuente de luz reemplazable por el usuario final

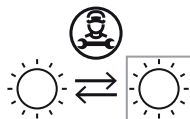

Replaceable light source by a professional
Fonte luminosa sostituibile da un professionista
Auswechselbare Lichtquelle durch einen Fachmann
Source lumineuse remplaçable par un professionnel
Fuente de luz reemplazable por un profesional



Replaceable (LED only) light source by end-user
Fonte luminosa (solo LED) sostituibile dal cliente finale
Auswechselbare (nur LED) Lichtquelle durch den Endanwender
Source lumineuse remplaçable (LED uniquement) par l'utilisateur final
Fuente de luz reemplazable (sólo LED) por el usuario final



Replaceable (LED only) light source by a professional
Fonte luminosa (solo LED) sostituibile da un professionista
Auswechselbare (nur LED) Lichtquelle durch einen Fachmann
Source lumineuse remplaçable (LED uniquement) par un professionnel
Fuente de luz reemplazable (sólo LED) por un profesional



Non-replaceable light source
Fonte luminosa non sostituibile
Nicht austauschbare Lichtquelle
Source lumineuse non remplaçable
Fuente de luz no reemplazable

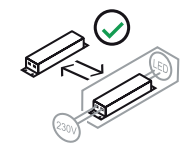

Replaceable control gear by end-user
Unità di alimentazione sostituibile dal cliente finale
Austauschbares Vorschaltgerät durch einen Endanwender
Pièce d'alimentation remplaçable par l'utilisateur final
Unidad de alimentación reemplazable por el usuario final

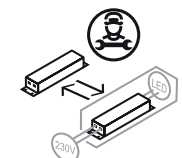

Replaceable control gear by a professional
Unità di alimentazione sostituibile da un professionista
Austauschbares Vorschaltgerät durch einen Fachmann
Pièce d'alimentation remplaçable par un professionnel
Unidad de alimentación reemplazable por un profesional

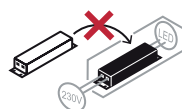

Non-replaceable control gear
Unità di alimentazione non sostituibile
Nicht austauschbares Vorschaltgerät
Pièce d'alimentation non remplaçable
Unidad de alimentación no reemplazable



5

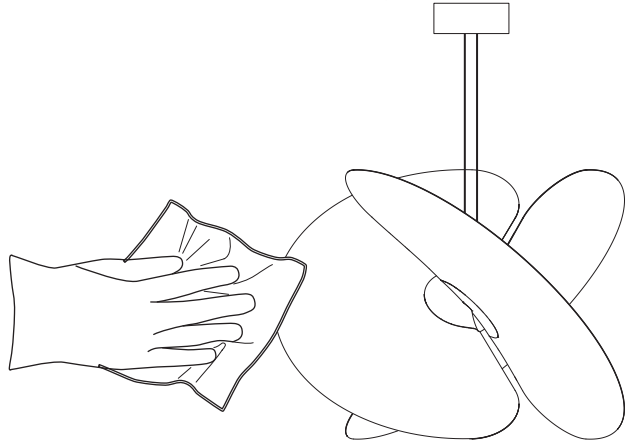
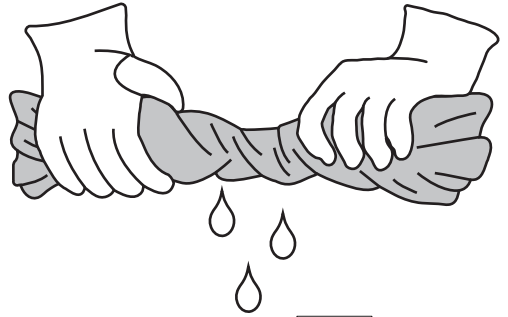
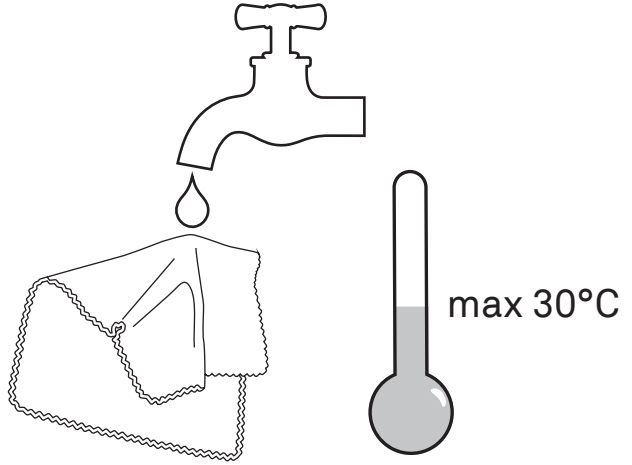
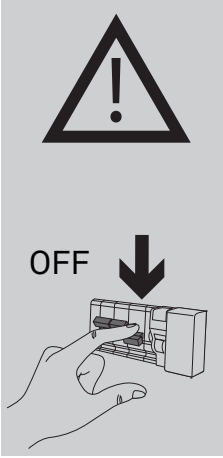



www.luceplan.com

A060IH0001