

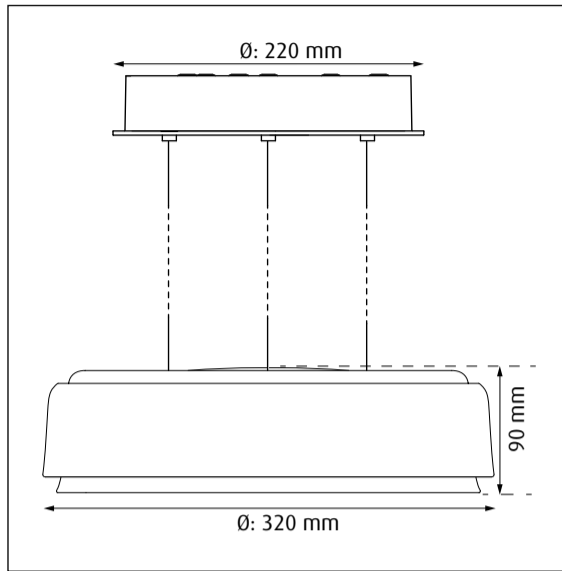







LP Grand 320 Suspended

louis
poulsen

Design Christian Flindt



17924-11

Lyskilde Light source Leuchtmittel Ljuskälla Sorgenti luminose Source lumineuse Fuente de luz Valonlähde	Spænding/frekvens Voltage/frequency Spannung/frequenz Spänning/frekvens Tensione/frequenza Voltage/frequence Tensión/frecuencia Jännite/taajuus	Vægt Weight Gewicht Vikt Peso/ingombro Poids Peso Paino	Isolationsklasse Electric shock protection Schutzklasse Isolationsklass Classe di isolamento Protection au choc électrique Clase de aislamiento Eristysluokka	Tæthedsklasse Ingress protection Schutzart Kapslingsklass Grado di protezione Indice de protection Clase de protección Kotelointiluokka	  	  
LED 	220-240V / 50-60Hz	2,6 kg	Cl. I	IP 20		

DA

Støv aftørres med en tør, blød klud. Fedtpletter og lignende kan fjernes med en blød klud opvredet i lunkent vand (<50° C) tilsat mildt rengøringsmiddel. Brug aldrig rengøringsmidler med slibemiddel eller opløsningsmidler.

EN

Wipe off dust with a dry, soft cloth. Remove greasy spots etc. with a soft cloth dampened in lukewarm water (<50° C) with a mild detergent. Never use detergents containing abrasives and solvents.

DE

Staub bitte mit einem trockenen, weichen Lappen abwischen. Fettflecke und dgl. mit einem feuchten, in lauwarmem Wasser (<50° C) mit mildem Reinigungsmittel ausgewungenen Lappen entfernen. Niemals Reinigungsmittel mit Schleifmittel oder Lösungsmittel verwenden.

SV

Lampan dammtorkas med en torr, mjuk trasa. Fettfläckar tas bort med ljummet vatten (<50° C) utblandat med mildt rengöringsmedel. Använd aldrig rengöringsmedel som innehåller slipmedel eller lösningsmedel

IT

Pulire la polvere esterna con un panno morbido e asciutto. Rimuovere macchie di grasso ecc. con un panno morbido inumidito in acqua tiepida (<50° C) e con un detergente leggero. Non usare mai detersivi contenenti abrasivi o solventi.

FR

Essuyez la poussière avec un chiffon sec et doux. Enlevez les points de saleté etc. avec un chiffon doux imprégné d'eau claire tiède et de détergent doux. Ne jamais utiliser de détergents contenant des abrasifs et des solvants.

ES

Limpiar con paño seco y suave. Quitar manchas de grasa y otras con paño suave humedecido con agua templada (<50° C) con detergente poco agresivo. Nunca use detergentes que contengan abrasivos y disolventes.

FI

Pyyhi pölyt kuivalla pehmeällä liinalla. Poista rasvatahrat miedolla pesuaineella ja haalealla vedellä (<50° C) kostutetulla pehmeällä liinalla. Älä koskaan käytä liuottimia tai hankausaineita sisältäviä pesuaineita.



DA

Lyskilden i dette armatur må kun udskiftes af producenten eller en uddannet elektriker. Forstærket isolation mellem LV forsyning og styrelederne.



EN

The light source contained in this luminaire shall only be replaced by the manufacturer or a qualified electrician. Reinforced insulation between LV supply and control.



DE

Das in dieser Leuchte enthaltene Leuchtmittel sollte nur vom Hersteller oder von einem qualifizierten Elektriker ausgetauscht werden. Verstärkte Isolierung zwischen Niederspannungsversorgung und Regler.



SV

Ljuskällan i denna armatur ska endast bytas ut av tillverkaren eller en kvalificerad elektriker. Förstärkt isolering mellan lågspänningskälla och strömbrytare.



IT

La sorgente contenuta in questa parte illuminante sarà solo riposizionata dal produttore o da un elettricista esperto. Isolamento rinforzato tra alimentazione e controllo LV.



FR

La source lumineuse de ce luminaire ne peut être remplacée que par le fabricant ou un électricien qualifié. Isolation renforcée entre l'alimentation basse tension et la commande.



ES

La sustitución de la fuente de luz que contiene esta luminaria debe ser llevada a cabo exclusivamente por el fabricante o un electricista profesional. Aislamiento reforzado entre fuente de baja tensión y control.



FI

Tämän valaisimen valonlähteen saa vaihtaa ainoastaan valmistaja tai koulutettu sähköasentaja. Vahvistettu eristys pienjännitteen syötön ja ohjauksen välillä.

